

Data sheet | Item number: 280-502/281-584

Component terminal block; double-deck; with end plate; with varistor; for DIN-rail 35 x 15 and 35 x 7.5; 2.5 mm²; CAGE CLAMP®

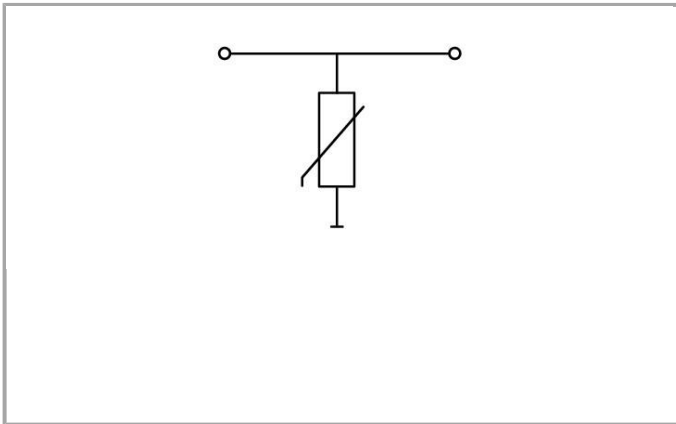

280-502/281-584

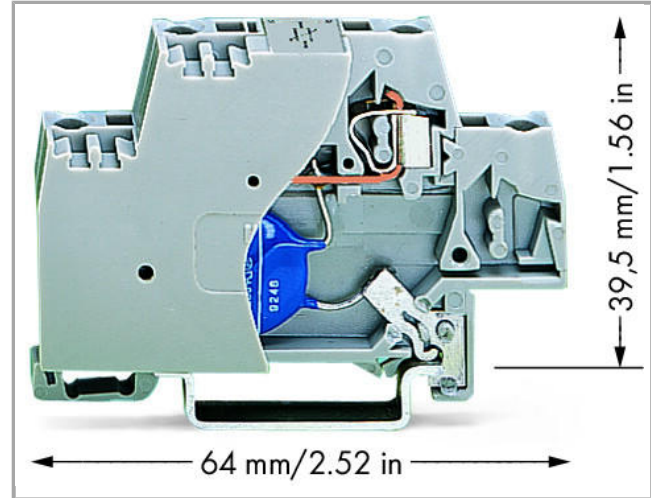
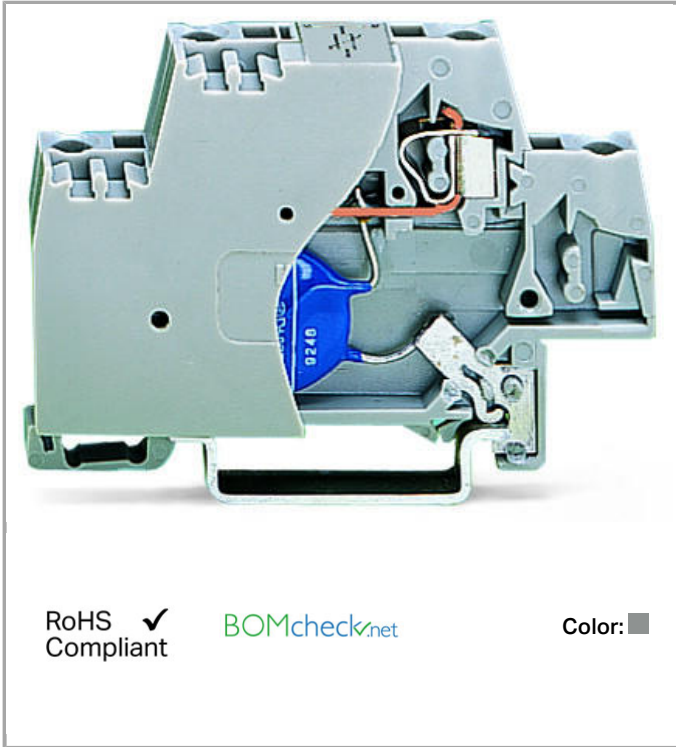

Item description

Short description:

Terminal blocks with surge suppression device and direct connection to the DIN-35 rail; these single-stage surge suppression devices are equipped either with 280 Series gas-filled surge arrester (coarse), varistor (medium) or suppressor diode (fine).

Features:

- Protect your system against overvoltage



- Slim, space-saving design
- Control operational costs by preventing expensive, unplanned downtime
- High operational reliability and system uptime

Data

Electrical data

Nominal operating voltage	DC 60 V
Maximum continuous operating voltage	DC 85 V
Rated continuous current	20 A
Nominal discharge current (8/20 μ s) per line	1 kA
Max. discharge current	4.5 kA
Voltage protection level (8/20 μ s)	\leq DC 165 V
Capacitance	\leq 1.7 nF

Connection data

Connections (number)	2
Connection technology	CAGE CLAMP®
Solid conductor	0.08 ... 2.5 mm ² / 28 ... 14 AWG
Fine-stranded conductor	0.08 ... 2.5 mm ² / 28 ... 14 AWG
Strip length	8 ... 9 mm / 0.31 ... 0.35 inch

Geometrical Data

Width	10 mm / 0.394 inch
Height from upper-edge of DIN-35 rail	39.5 mm / 1.555 inch
Depth	64 mm / 2.52 inch

Mechanical data

Design	With end plate; with direct connection to DIN rail
Type of mounting	DIN-35 rail

Material Data

Color	gray
Fire load	0.268 MJ
Weight	12.7 g

Commercial data













Product Group	1 (Rail Mounted Terminal Blocks)
Country of origin	DE
GTIN	4050821688433

Customs Tariff No.

85369010000

Compatible products

Marking accessories

	Item no.: 2009-145 Mini-WSB Inline; for Smart Printer; on reel; stretchable 5 - 5.2 mm; plain; snap-on type		2009-145
	Item no.: 2009-145/000-002 Mini-WSB Inline; for Smart Printer; on reel; stretchable 5 - 5.2 mm; plain; snap-on type	/000-002	2009-145
	Item no.: 2009-145/000-005 Mini-WSB Inline; for Smart Printer; on reel; stretchable 5 - 5.2 mm; plain; snap-on type	/000-005	2009-145
	Item no.: 2009-145/000-006 Mini-WSB Inline; for Smart Printer; on reel; stretchable 5 - 5.2 mm; plain; snap-on type	/000-006	2009-145
	Item no.: 2009-145/000-007 Mini-WSB Inline; for Smart Printer; on reel; stretchable 5 - 5.2 mm; plain; snap-on type	/000-007	2009-145
	Item no.: 2009-145/000-012 Mini-WSB Inline; for Smart Printer; on reel; stretchable 5 - 5.2 mm; plain; snap-on type	/000-012	2009-145
	Item no.: 2009-145/000-023 Mini-WSB Inline; for smartPRINTER; on reel; stretchable 5 - 5.2 mm; plain; snap-on type	/000-023	2009-145
	Item no.: 2009-145/000-024 Mini-WSB Inline; for Smart Printer; on reel; stretchable 5 - 5.2 mm; plain; snap-on type	/000-024	2009-145
	Item no.: 248-501 Miniature WSB Quick marking system; plain; Marker width 5 mm; 10 strips with 10 markers per card		248-501
	Item no.: 248-501/000-002 Mini-WSB marking card; as card; not stretchable; plain; snap-on type	/000-002	248-501
	Item no.: 248-501/000-005 Mini-WSB marking card; as card; not stretchable; plain; snap-on type	/000-005	248-501
	Item no.: 248-501/000-006 Mini-WSB marking card; as card; not stretchable; plain; snap-on type	/000-006	248-501



Item no.: 248-501/000-007
Mini-WSB marking card; as card; not stretchable; plain; snap-on type

/000-007

248-501



Item no.: 248-501/000-012
Mini-WSB marking card; as card; not stretchable; plain; snap-on type

/000-012

248-501



Item no.: 248-501/000-017
Mini-WSB marking card; as card; not stretchable; plain; snap-on type

/000-017

248-501



Item no.: 248-501/000-023
Mini-WSB marking card; as card; not stretchable; plain; snap-on type

/000-023

248-501



Item no.: 248-501/000-024
Mini-WSB marking card; as card; not stretchable; plain; snap-on type

/000-024

248-501

Jumper



Item no.: 280-482
Comb-style jumper bar; insulated; 2-way; IN = IN terminal block

280-482



Item no.: 280-483
Comb-style jumper bar; insulated; 3-way; IN = IN terminal block

280-483



Item no.: 280-484
Comb-style jumper bar; insulated; 4-way; IN = IN terminal block

280-484



Item no.: 280-485
Comb-style jumper bar; insulated; 5-way; IN = IN terminal block

280-485



Item no.: 280-490
Comb-style jumper bar; insulated; 10-way; IN = IN terminal block

280-490



Item no.: 280-492
Alternate comb-style jumper bar; insulated; 2-way; IN = IN terminal block

280-492

Insulation stop



Item no.: 280-470
Insulation stop; 0.08 - 0.2 mm² "s" (0.14 mm² "f-st"); 5 pieces/strip

280-470



Item no.: 280-471
Insulation stop; 0.25 - 0.5 mm²; 5 pieces/strip

280-471



Item no.: 280-472
Insulation stop; 0.75 - 1 mm²; 5 pieces/strip

280-472

End plate



Item no.: 280-340
End and intermediate plate; 2.5 mm thick

280-340



Item no.: 280-341
End and intermediate plate; 2.5 mm thick

280-341

tools

Item no.: 210-720



Operating tool with partially insulated shaft; Type 2, blade (3.5 x 0.5) mm

210-720

Downloads

Documentation

Additional Information

Disposal; Electrical and electronic equipment, Packaging	V 1.0.0	pdf 265.8 kB	Download
--	---------	-----------------	----------

CAD/CAE - Smart Data

CAD data

3D Download 280-502/281-584	URL	Download
-----------------------------	-----	----------

Subject to changes.
